

Express Lifts Alliance Group

 TRIVIUM



ENTER ANOTHER DIMENSION



A NEW CONCEPT OF ELEVATOR

THE NEW GENERATION OF **TRIVIUM** ELEVATORS HAS MANAGED TO OVERCOME SOME CHALLENGES THAT SEEMED IMPOSSIBLE.

TRIVIUM IS A NEW CONCEPT OF ELEVATOR WITH THE MOST MODERN TECHNOLOGY THAT EXISTS IN THE MARKET. THE USE OF THE UNIQUE SYSTEM OF FLAT POLYURETHANE-COATED STEEL BELTS CONVERTS IT INTO A HIGHLY EFFICIENT FUNCTIONAL ELEVATOR. SMOOTHER AND QUIETER. FASTER AND SAFER.

NEW CONCEPTS OF
QUALITY, COMFORT
AND ENVIRONMENTAL
RESPONSIBILITY

TRIVIUM



QUALITY

COMFORT

ENVIRONMENTAL
RESPONSIBILITY

VS

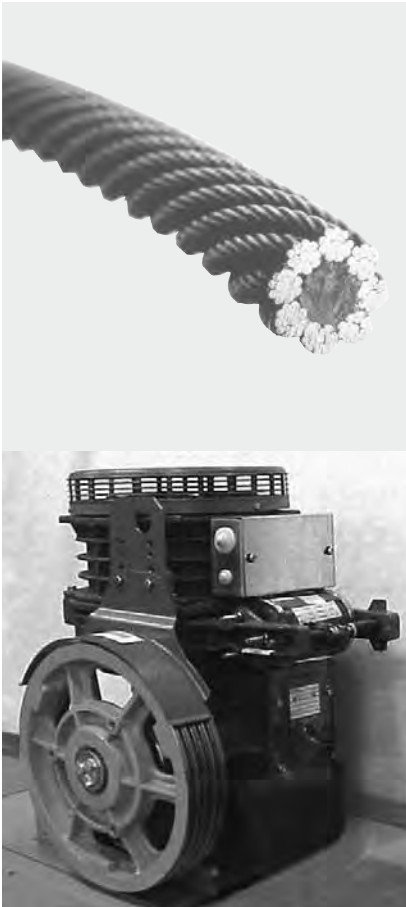

CONVENTIONAL WIRE ROPES VS FLAT STEEL BELTS

Our flat polyurethane-coated steel belts have the flexibility searched for with conventional wire ropes. The rigidity of wire ropes limited the bending radius needed to design smaller elevator machinery and to save space.



CONVENTIONAL MACHINE VS GEARLESS MACHINE

The gearless machine with a permanent magnet motor of radial construction guarantees maximum comfort and safety and reduces the space required by the machine by 70%.

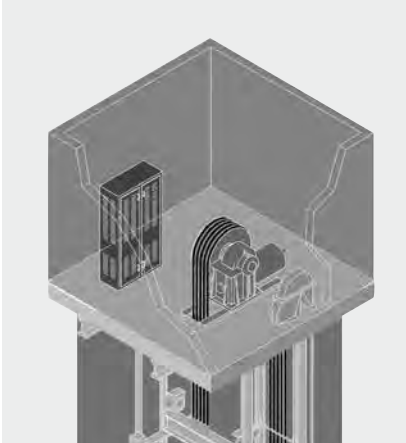

ELEVATOR WITH MACHINE ROOM VS ELEVATOR WITHOUT MACHINE ROOM

No machine room required (the rooftop construction is eliminated). The machine is installed on the car guide rails and the counterweight rails, avoiding loads being transferred to the pit and thus reducing the structural costs of the building.

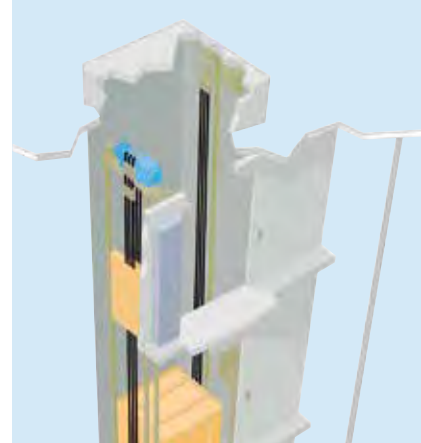

TRIVIUM

THE NEW GENERATION OF ELEVATORS

ADVANTAGES



- 1** The use of **flat belts**
 - Provides smoother, quieter operation as well as extraordinary levelling accuracy.
 - Eliminates the lubrication of traditional wire ropes.
 - Does not damage the sheaves, which can therefore last practically forever. Less wear and longer life of the components is guaranteed.
- 2** The **permanent-magnet gearless machine**
 - Does not generate any hazardous waste as the sealed machine has lubricated-for-life bearings thus contributing to the protection of the Environment.
 - Leads to a reduction in energy consumption.
 - Reduces structural costs on account of the small space required by the machine, up to 70% less than a conventional machine.
- 3** Its **patented rescue system**, with battery-operated electronic monitoring of speed, guarantees a fast, safe, and effective rescue.
- 4** The **TRIVIUM installation** process is fast and safe and does not interfere with other trades.
- 5** The closed-loop speed control enables smoother starts and deceleration, a faster trip and outstanding stopping accuracy.



The TRIVIUM elevator has weathered conditions of extreme temperatures and has successfully withstood all types of tests: voltage variations, power cuts and virtually, every possible breakdown of a building's electrical system

The pulse system

Continuously monitors the status of the steel belts 24 hours a day, 365 days a year.

Door deterrent device

If the car is stopped between floors, a special deterrent device prevents the car doors from opening. Hence a person cannot take the risk of exiting without following the safety procedures.

Hoistway access detection

To protect the maintenance technicians, a special safety feature prevents the elevator from operating after a landing door has been opened unless the car is on that floor.

Automatic rescue system

A patented rescue system, with battery-operated electronic monitoring of speed, guarantees a fast, safe, effective rescue.

Entrance protection

A screen of infrared beams acts as an invisible safety curtain. When an obstacle breaks this screen, the entrance protection system detects it and immediately reopens the doors.

Outstanding levelling accuracy

The reduced stretching of the flat belts compared with conventional ropes, as well as the use of a closed-loop variable frequency drive, provides outstanding levelling accuracy (+/- 3 mm at all stops).

Machine brake system

For the purpose of improving safety, the dual brake system of the machine is equipped with two switches that prevent the elevator from moving until the brake is completely released.

24h Service

Our technicians have a preventive maintenance system in order identify possible anomalies and to rectify them before they affect the availability of the elevator.

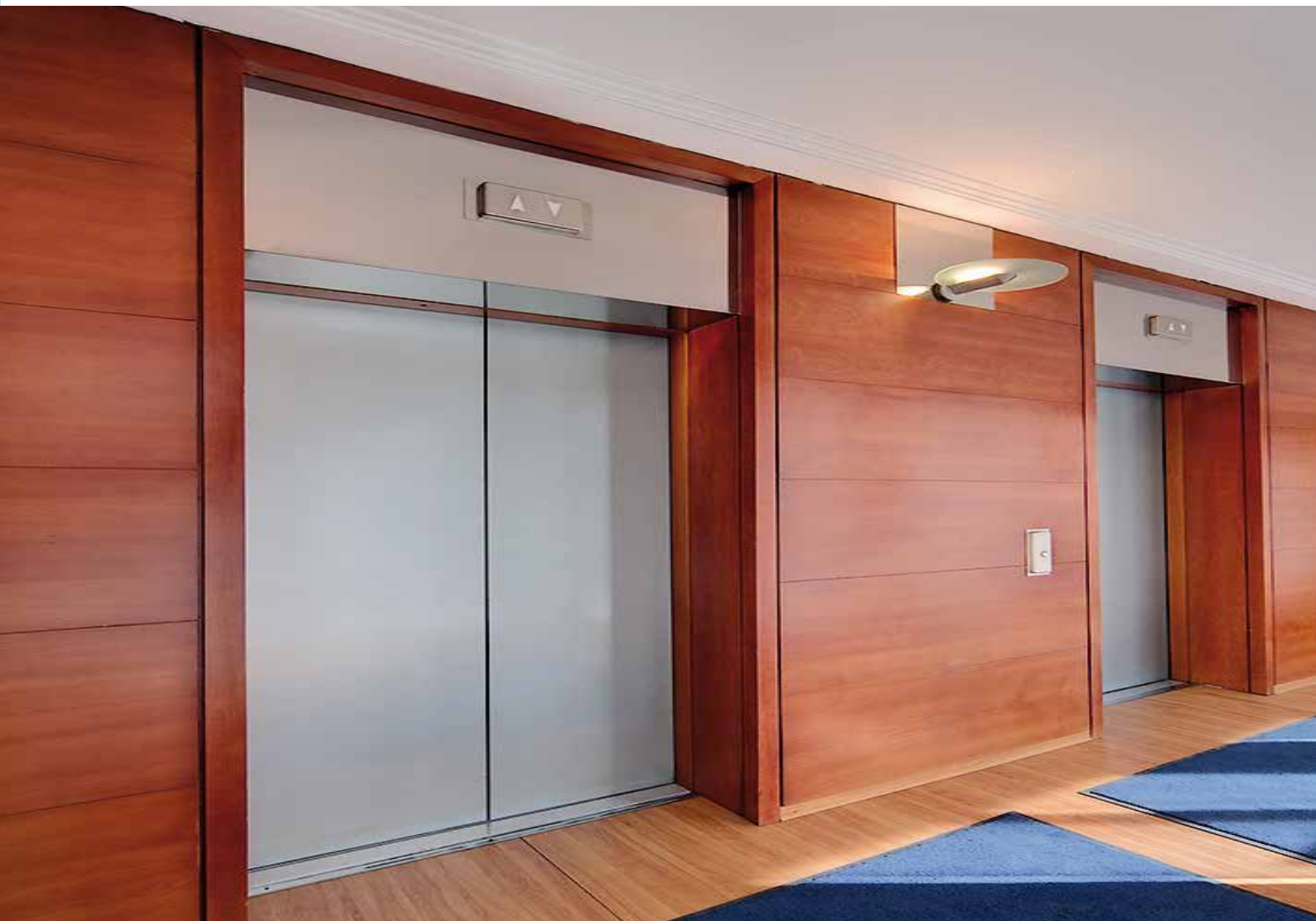



TRIVIUM

RESPECTS THE ENVIRONMENT

LUBRICATION-FREE AND ENERGY EFFICIENT

Neither the belts nor the machine with sealed bearings require any type of polluting lubricant.

The low-inertia, gearless machine has a closed-loop, variable frequency motion control that achieves:

- Substantial energy savings compared with conventional machines that are much larger.
- Lower operational costs due to the reduced power supply installed.
- Reduced currents during acceleration and normal run, resulting in further savings in the electrical installation.

SAVINGS OF UP TO 70%

TRIVIUM elevators can save up to 70% of the energy consumption of the motor. The table below compares the nominal power and the consumption of the motor -according to type of elevator- as well as the car lighting consumption, depending on whether they have automatic switch-off or not:

Elevator	Hydraulic		2-Speed Traction		TRIVIUM	
	Power	Consumption	Power	Consumption	Power	Consumption
4	7.7 kW	1790 kWh / year	3.3 kW	1150 kWh / year	2.2 kW	590 kWh / year
6	9.5 kW	2200 kWh / year	5.0 kW	1330 kWh / year	3.2 kW	660 kWh / year
8	11.0 kW	2520 kWh / year	5.0 kW	1470 kWh / year	4.2 kW	770 kWh / year
Car lighting	Consumption without automatic switch-off		Consumption without automatic switch-off		Consumption with automatic switch-off	
	530 kWh / year		530 kWh / year		130 kWh / year	

Comparison of energy consumption taking an average car load of 300 kg and 80,000 trips a year. Nominal speed of the TRIVIUM and the 2-speed traction elevator: 1 m/s. Nominal speed of the hydraulic elevator: 0.63 m/s.





The savings obtained, in kWh and in euros, thanks to the TRIVIUM and its automatic car lighting switch-off system, are as follows:

Elevator	Hydraulic	2-Speed Traction	Hydraulic	2-Speed Traction
	Energy savings		Financial savings	
4	1200 kWh (67.0%)	560 kWh (48.7%)	185 €	90 €
6	1540 kWh (70.0%)	670 kWh (50.4%)	235 €	105 €
8	1750 kWh (69.4%)	700 kWh (47.6%)	265 €	110 €
Car lighting	400 kWh (75.5%)	400 kWh (75.5%)	60 €	60 €

A further €240 annual savings can be added to the above for the reduction in contracted power.

TRIVIUM elevators require less current during acceleration and normal run, resulting in savings when measuring up the installation.

We calculate that if all the existing elevators in Spain were replaced by TRIVIUM elevators, 750 million kWh would be saved each year, which is equivalent to the domestic energy consumption of a city like Bilbao.

This would lead to a reduction in CO₂ emissions of 490 million kilograms a year, equivalent to the emissions of 150,000 automobiles.

NOTE: The savings in euros may vary according to the tariff applied by the electric company.



ENERGY EFFICIENCY

Regenerative System

Generates energy for the building

The TRIVIUM elevator is equipped with a regenerative system, a new energy-efficient technology that can deliver savings of up to 75% compared to conventional elevators.*

When the car is heavily or fully loaded, it utilizes gravity to descend and the motor produces energy instead of consuming it just like a generator. The same occurs when the empty or lightly loaded car ascends; the counterweight descends by the effect of gravity and the motor generates energy.

The regenerative system is able to make use of this energy and feed it back into the building grid, where it can be used to power other electrical components.

It produces clean power thanks to low harmonic distortion of the incoming line current, which minimises impact on the building's electrical system and helps protect sensitive equipment.

The systems can withstand significant voltage fluctuations and are designed to operate with standard voltages from 170 to 528 volts, making them the ideal choice for any installation.

With regenerative systems we are leading the way towards a more energy efficient and sustainable future.

*Based on 1000 kg elevators at 1.0 m/s, 8 stops and 300,000 starts/year.
Comparison in consumption between a TRIVIUM with regenerative systems and a hydraulic elevator.

Options: lighting

LED lighting

LED lighting can provide energy savings of at least 50%, with respect to other systems such as fluorescent lights or halogen lamps.

It does not generate heat, which is important in a small space such as an elevator car and lasts at least 10 times longer than other lighting systems

Automatic car lighting switch off

The car lighting remains on 24 hours a day, 365 days a year, even when there is no passenger demand for the elevator or it is parked for hours and hours.

The solution in order to avoid this useless waste of energy is car lighting that switches off automatically.

If the elevator is not in use, the car lighting is turned off after a certain amount of time and it remains off until the doors are opened when it returns to service. This could result in savings of up to 70% of the energy consumed by the car lighting.



TECHNICAL SPECIFICATIONS

Load Capacity

320 kg (4 passengers)	525 kg (7 passengers)	800 kg (10 passengers)	1250kg (16 passengers)
400 kg (5 passengers)	630 kg (8 passengers)	900kg (12 passengers)	1600kg (21 passengers)
450 kg (6 passengers)	675 kg (9 passengers)	1000 kg (13 passengers)	

Speed

1.0 m/s (all load capacities)	1.6 m/s and 1.75 m/s (6, 8, 10, 12 and 13 passengers)
-------------------------------	---

Rise

Maximum 45 m; 16 stops, (1 m/s)	Maximum 75 m; 24 stops, (1.75 m/s)
---------------------------------	------------------------------------

Traction

Gearless sealed machine with permanent-magnet motor.
Traction by means of flat belts.

Control

Variable Frequency OVF-20.

Controller

Modular Control System, MCS 220, operated by microprocessors, combined with the most advanced variable frequency and variable voltage system.

Harmonics Filter CHF.

Located on the door column on the top floor. As an option, it can be installed up to a distance of 20 metres away. Two-way communication system in compliance with EN 81-28. Remote intervention system.

Operation

Simple automatic. Down collective. Full collective.
Up to two or three elevators in a group.

Types of doors

Automatic, two-panel, telescopic or centre-opening doors, depending on model.

Equipped with a variable-speed, digital control system, a self-cleaning slotted sill and aluminium door track with protected roller system.

Stainless steel or primed, ready-to-paint finish.

The landing doors comply with EN 81-58.

Entrances

One or two entrances (180°).

Load Capacity	Car CWxCD	Hoistway HWxHD	Door opening OP
450 Kg (6p)	1000x1250	1 entrance 1550x1500	800
		2 ent. 180° 1550x1600	Telescopic
		1 entrance 1830x1500	800
		2 ent. 180° 1830x1600	C. Opening
		1 entrance 1690x1500	900
		2 ent. 180° 1690x1600	Telescopic
630 Kg (8p)	1100x1400	1 entrance 1610x1650	800
		2 ent. 180° 1610x1750	Telescopic
		1 entrance 1830x1650	800
		2 ent. 180° 1830x1750	C. Opening
		1 entrance 1690x1650	900
		2 ent. 180° 1690x1750	Telescopic
800 Kg (10p)	1350x1400	1 entrance 2010x1650	900
		2 ent. 180° 2010x1750	C. Opening
		1 entrance 1905x1650	900
		2 ent. 180° 1905x1750	Telescopic
		1 entrance 2015x1650	900
		2 ent. 180° 2015x1750	C. Opening
900 Kg (12p) Deep car	1100x1800	1 entrance 1800x2050	800
		2 ent. 180° 1800x2130	C. Opening
		1 entrance 1650x2050	900
		2 ent. 180° 1650x2130	Telescopic
		1 entrance 2000x2050	900
		2 ent. 180° 2000x2130	C. Opening
900 Kg (12p)	1400x1500	1 entrance 1850x2050	1000
		2 ent. 180° 1850x2130	Telescopic
		1 entrance 1950x1770	900
		2 ent. 180° 1950x1880	Telescopic
		1 entrance 1975x1770	900
		2 ent. 180° 1975x1880	C. Opening
1000 Kg (13p)	1400x1600	1 entrance 1950x1850	900
		2 ent. 180° 1950x1950	Telescopic
		1 entrance 1975x1850	900
		2 ent. 180° 1975x1950	C. Opening
		1 entrance 1650x2350	900
		2 ent. 180° 1650x2450	Telescopic
1000 Kg (13p) Deep car	1100x2100	1 entrance 1850x2350	1000
		2 ent. 180° 1850x2450	Telescopic
		1 entrance 2200x1650	900
		2 ent. 180° 2200x1750	C. Opening
		1 entrance 2250x1650	1000
		2 ent. 180° 2250x1750	C. Opening
1000 Kg (13p) Wide car	1600x1400	1 entrance 2450x1650	1100
		2 ent. 180° 2450x1750	C. Opening

Pit S=1.150 (at 1.6 m/s). Pit S=1250 (at 1.75 m/s).

CONFIGURATION AND DIMENSIONS
AT 1.6 m/s and 1.75 m/s

(*) Door height	Car height	Overhead clearance (K) at 1.6 & 1.75 m/s	Availability
2000	2200	3550 (at 1,6 m/s)	standard
2100	2300	3650 (at 1,6 m/s)	optional
2000	2200	3400 (at 1,75 m/s)	standard
2100	2300	3700 (at 1,75 m/s)	optional

Dimensions in millimetres – Doors mounted on landing – Dimensions of the controller cabinet: 330 mm wide x 90 mm deep x 2100 mm high for 6 and 8 p. and 400 mm wide x 160 mm deep x 2000 mm high for 10 to 13 p. (1000 kg). Right reserved to modify models without prior notice, as well as their characteristics, equipment and accessories, providing it is an improvement to the installation.

Vertical Section

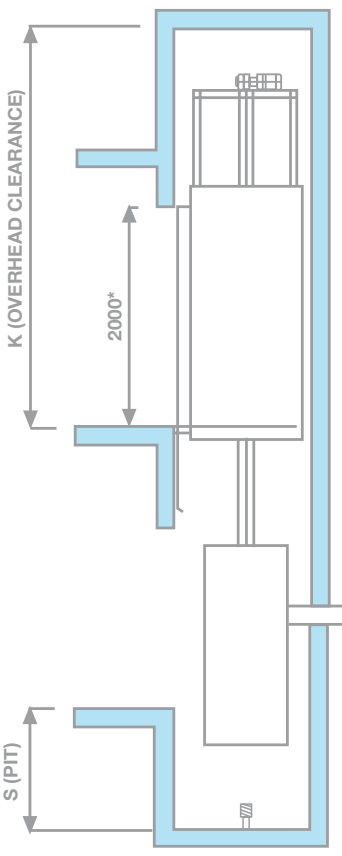

Floor plan
one entrance, telescopic door

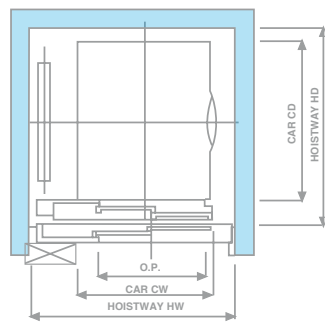

Floor plan
two entrances, telescopic door

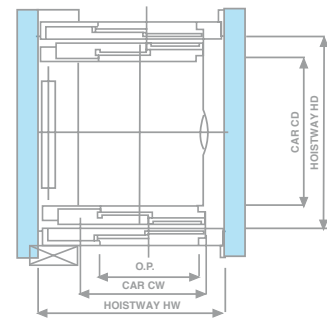

Floor plan
one entrance, centre-opening door

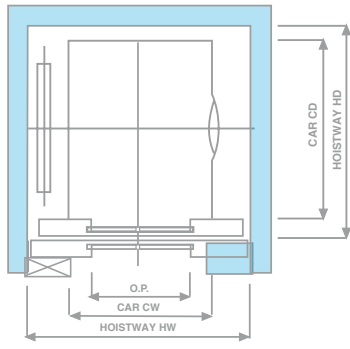

Floor plan
two entrances, centre-opening door

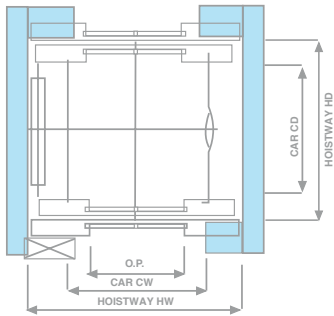

Load Capacity	Car CWxCD	Hoistway HWxHD	Door opening OP
320 Kg (4p)	840x1050	1 entrance	1380x1300
		2 ent. 180°	1380x1400
400 Kg (5p)	840x1200	1 entrance	1380x1450
		2 ent. 180°	1380x1550
450 Kg (6p)	1000x1250	1 entrance	1550x1500
		2 ent. 180°	1550x1600
525 Kg (7p)	1000x1300	1 entrance	1830x1500
		2 ent. 180°	1830x1600
630 Kg (8p)	1100x1400	1 entrance	1690x1500
		2 ent. 180°	1690x1600
675 Kg (9p)	1100x1450	1 entrance	1550x1550
		2 ent. 180°	1550x1650
800 Kg (10p)	1350x1400	1 entrance	1830x1550
		2 ent. 180°	1830x1750
900 Kg (12p) Cabina profunda	1100x1800	1 entrance	1690x1650
		2 ent. 180°	1690x1750
900 Kg (12p)	1400x1500	1 entrance	2010x1650
		2 ent. 180°	2010x1750
1000 Kg (13p)	1400x1600	1 entrance	1610x1700
		2 ent. 180°	1610x1800
1000 Kg (13p) Cabina profunda	1100x2100	1 entrance	1830x1700
		2 ent. 180°	1830x1800
1000 Kg (13p) Cabina ancha	1600x1400	1 entrance	1690x1700
		2 ent. 180°	1690x1800
1250 Kg (16p)	1200x2300	1 entrance	2010x1700
		2 ent. 180°	2010x1800
1600 Kg (21p)	1400x2400	1 entrance	1610x1700
		2 ent. 180°	1610x1800
	2050x1700	1 entrance	1830x1700
		2 ent. 180°	1830x1800
		1 entrance	1950x1770
		2 ent. 180°	1950x1880
		1 entrance	1975x1770
		2 ent. 180°	1975x1880
		1 entrance	1950x1850
		2 ent. 180°	1950x1950
		1 entrance	1975x1850
		2 ent. 180°	1975x1950
		1 entrance	1650x2350
		2 ent. 180°	1650x2450
		1 entrance	1850x2350
		2 ent. 180°	1850x2450
		1 entrance	2200x1650
		2 ent. 180°	2200x1750
		1 entrance	2250x1650
		2 ent. 180°	2250x1750
		1 entrance	2450x1650
		2 ent. 180°	2450x1750
		1 entrance	1950x2550
		2 ent. 180°	1950x2680
		1 entrance	2080x2700
		2 ent. 180°	2080x2900
		1 entrance	2900x1950
		2 ent. 180°	2900x2100

Pit S=1000 (at 1 m/s).
For other hoistway dimensions, we have cars with variable dimensions at 1 m/s. Please consult local representative.

(*) Door height	Car height	Overhead clearance (K) at 1 m/s	Availability
2000	2100	3300	Optional up to 13 p.
2000	2200	3400	Standard up to 13 p.
2100	2300	3500	Optional up to 13 p. and standard up to 16 p.
2100	2300	3600	Standard up to 21 p.

For less overhead clearance, please consult local representative.

Dimensions in millimetres – Doors mounted on landing – Dimensions of the controller cabinet: 330 mm wide x 90 mm deep x 2100 mm high for 6 and 8 p. and 400 mm wide x 160 mm deep x 2000 mm high for 10 to 13 p. (1000 kg).
Right reserved to modify models without prior notice, as well as their characteristics, equipment and accessories, providing it is an improvement to the installation.



AESTHETICS INNOVA

APARTMENTS
OFFICES
PUBLIC BUILDINGS



SKINPLATE PANELS



RUBBER FLOORINGS

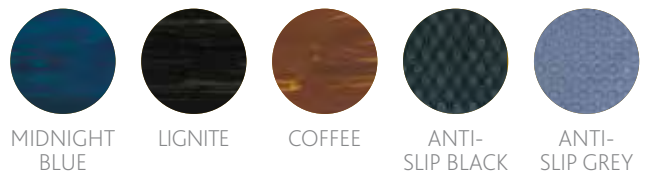

ARTIFICIAL STONE FLOORINGS



MARBLE OR GRANITE FLOORINGS CAN ALSO BE INSTALLED ON SITE.



AESTHETICS NATURA

APARTMENTS
OFFICES
HOTELS
PUBLIC BUILDINGS

LAMINATED PANELS

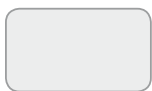

CARRARA
WHITE



TITIAN GREY



NUBIA
SANDSTONE



LOTUS



ROUGH
PEACH

ARTIFICIAL STONE FLOORINGS



BONE

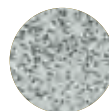

CLOUD



BLUE

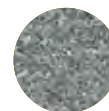

DOLPHIN



BLACK

ROUGH PEACH MARBLE OR GRANITE FLOORINGS CAN ALSO BE INSTALLED ON SITE



AESTHETICS SERENA

APARTMENTS
OFFICES
HOTELS
PUBLIC BUILDINGS



OPTIONS

STAINLESS STEEL PANELS



STAINLESS
STEEL

ARTIFICIAL STONE FLOORINGS



BONE

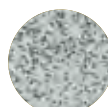

CLOUD



BLUE

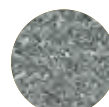

DOLPHIN



BLACK

MARBLE OR GRANITE FLOORINGS CAN ALSO BE INSTALLED ON SITE.



AESTHETICS SUPRA

APARTMENTS
OFFICES
HOTELS

SUITABLE FOR EXCLUSIVE BUILDINGS

THE QUALITY AND THE DESIGN OF THE DIFFERENT FINISHES OFFERED BY TRIVIUM MAKE IT THE IDEAL ELEVATOR FOR EXCLUSIVE BUILDINGS, ALLOWING YOU TO CUSTOMIZE EACH PART OF YOUR ELEVATOR.

A NEW CONCEPT OF DESIGN



OPTIONS



LIGHTING



CURVED WITH DOWNLIGHTS



FLAT WITH FALSE DOWNLIGHTS

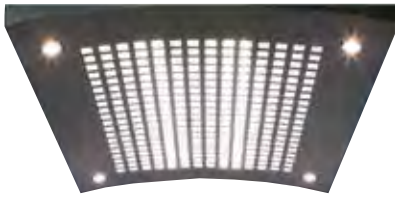

CURVED WITH DOWNLIGHTS AND GRILLE



ZENITH

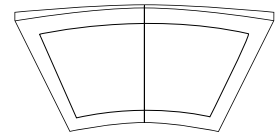
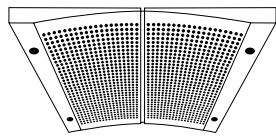
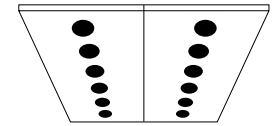
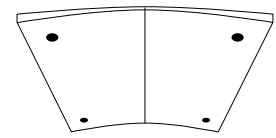

Depending on the dimensions of the car, the decorative ceilings can be supplied in 2 parts.

CEILING FINISHES



WHITE SKINPLATE



STAINLESS STEEL

HANDRAILS

HANDRAIL MIRROR FINISH



HANDRAIL SATIN FINISH

MIRRORS

MIRROR PANEL

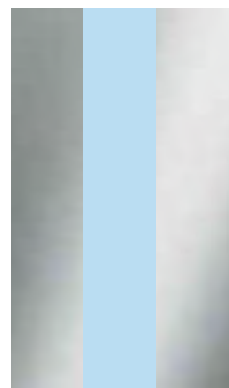
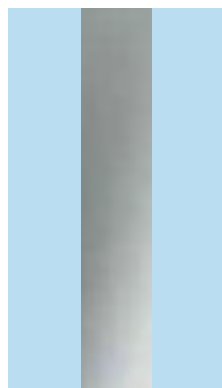
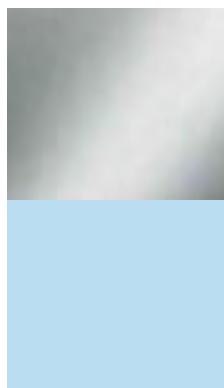



← CAR BUTTONS AND OPERATING PANEL



↑ HALL POSITION INDICATOR



↑ HALL POSITION INDICATOR



← (OPTIONAL)



↑ DIRECTION INDICATORS



← HALL BUTTONS →





TRIVIUM

123 Abbey Lane, Leicester, LE4 5QX

Office no: 0116 225 2100

www.elagroup.co.uk